

Distributed I/O device 2 Volt / mA output channels communicating over RS-485

DAT 3022

FEATURES

- Modbus Server device on RS-485
- Modbus RTU/ Modbus ASCII protocol
- 2 output channels
- Outputs configurable as Voltage or Current
- Watch-Dog Alarm
- Remotely Configurable
- 2000 Vac 3-ways Galvanic Isolation
- LED of signalling on front side for power supply and communication
- Connection by removable screw terminals
- High accuracy
- CE / UL / UKCA mark
- DIN rail mounting in compliance with EN-50022



GENERAL DESCRIPTION

The DAT 3022 device generates 2 output analog signals from digital commands. The data are transmitted with MODBUS RTU/MODBUS ASCII protocol on the RS-485 network (RS-232 interface is available). It is possible to generate voltage signals up to 10V and current signals up to 20mA, both active or passive loops.

The device guarantees high accuracy and stable measure versus time and temperature.

To ensure the plant safety, it is provided a Watch-Dog timer alarm.

The isolation between the parts of circuit removes eventual ground-loop effects, allowing the use of the device even in the heavy environmental conditions. The device is in compliance with the Directive UL 61010-1 for US market and with the Directive CSA C22.2 No 61010-1 for the Canadian market. It is housed in a rough self-extinguishing plastic container which, thanks to its thin profile of 17.5mm only, allows a high density mounting on EN-50022 standard DIN rail.

USER INSTRUCTIONS

Before to install the device, please read the "Installation Instruction" section.

If the module configuration is unknown, with device powered off, connect the INIT terminal to the GND terminal (ground), at the next power on the device will be auto-configured in the default settings (refer to the User Guide of the device).

Connect power supply, serial bus and analogue outputs as shown in the "Wiring" section.

The "PWR" LED state depends on the working condition of the device: see the "Light Signalling" section to verify the device working state.

To perform configuration and calibration operations, read the instructions in the User Guide of the device.

To simplify handling or replacing of the device, it is possible to remove the wired terminals even with the device powered.

TECHNICAL SPECIFICATIONS (Typical @ 25 °C and in the nominal conditions)

OUTPUT (2 CHANNELS)			SERIAL OUTPUT		GENERAL SPECIFICATIONS	
Output Type	Min	Max	Data Transmission		Power supply voltage	18 .. 30 Vdc
Current mA	0 mA	+ 20 mA	RS-485 asynchronous serial Baud Rate 115.2 Kbps Max. distance 1.2 Km – 4000 ft		Reverse polarity protection	60 Vdc max
Voltage Volt	0 V	+ 10 V			Max. Current consumption	60 mA
Output Accuracy					ISOLATION	Among all the ways
Current	± 20 uA				ENVIRONMENTAL CONDITIONS	
Voltage	± 10 mV				Operative temperature	-10°C .. +60°C
Thermal drift					UL Operative Temperature	-10°C .. +40°C
Full scale	± 0.01 % / °C				Storage temperature	-40°C .. +85°C
Load resistance					Humidity (not condensing)	0 .. 90 %
Voltage	≥ 5 KΩ				Maximum Altitude	2000 m slm
Current	≤ 500 Ω				Installation	Indoor
Auxiliary Voltage (2 channels)					Category of Installation	II
	> 12V @ 20mA				Pollution Degree	2
Response time					MECHANICAL SPECIFICATIONS	
Slew-rate analogue output (with dedicated setting for each channel)					Material	Self-extinguish plastic
Value	V/s	mA/s			IP Code	IP20
00h	Disabled				Wiring	wires with diameter 0.8±2.1 mm ² AWG 14-18
01h	0.15	0.30			Tightening Torque	0.5 N m
02h	0.30	0.60			Mounting	in compliance with DIN rail standard EN-50022
03h	0.60	1.20			Weight	about 150 g.
04h	1.20	2.40			CERTIFICATIONS	
05h	2.40	4.80			EMC (for the Industrial Environments)	
06h	4.80	9.60			Immunity	EN 61000-6-2
07h	9.60	19.2			Emission	EN 61000-6-4
08h	19.2	38.4			UKCA (ref S.I. 2016 N°1091)	
09h	38.4	76.8			Immunity	BS EN 61000-6-2
0Ah	76.8	153			Emission	BS EN 61000-6-4
0Bh	153	306			UL	
0Ch	Immediate				US Standard	UL 61010-1
					Canadian Standard	CSA C22.2 No 61010-1
					CCN	NRAQ/NRAQ7
					Typology	Open Type device
					Classification	Industrial Control Equipment
					File Number	E352854

INSTALLATION INSTRUCTIONS

The device is suitable for fitting to DIN rails in the vertical position. For an optimum operation and long life follow these instructions: When the devices are installed side by side it may be necessary to separate them by at least 5 mm if panel temperature exceeds 45°C and at least one of the overload conditions exist or if panel temperature exceeds 35°C and at least two of the overload conditions exist. The overload conditions are the following:

- High supply voltage: >27Vdc
- Use of the auxiliary power supply

Make sure that sufficient air flow is provided for the device avoiding to place raceways or other objects which could obstruct the ventilation slits. Moreover it is suggested to avoid that devices are mounted above appliances generating heat; their ideal place should be in the lower part of the panel. Install the device in a place without vibrations. Moreover it is suggested to avoid routing conductors near power signal cables (motors, induction ovens, inverters etc...) and to use shielded cable for connecting signals.

CABLING

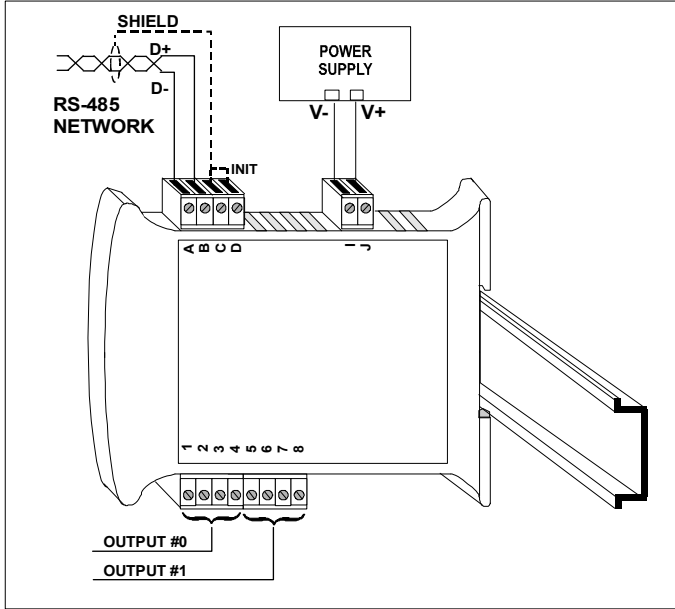

LIGHT SIGNALLING

LED	COLOR	STATE	DESCRIPTION
PWR	GREEN	ON	Device powered
		OFF	Device not powered / Wrong RS-485 cabling.
		FAST BLINKING	Communication in progress (the blinking frequency depends to baud-rate)
		1 second BLINKING	Watch-Dog Alarm condition

ISOLATION STRUCTURE

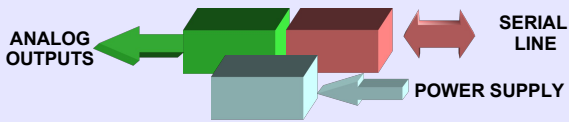

MECHANICAL DIMENSIONS (mm)

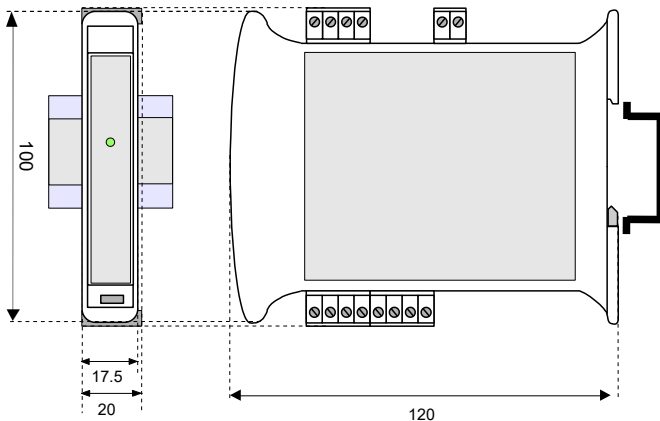

The symbol reported on the product indicates that the product itself must not be considered as a domestic waste. It must be brought to the authorized recycle plant for the recycling of electrical and electronic waste. For more information contact the proper office in the user's city, the service for the waste treatment or the supplier from which the product has been purchased.

WIRING

POWER SUPPLY (*)

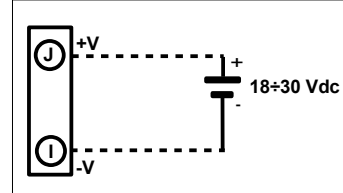

INIT

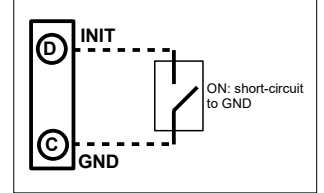

(*) Note: for UL installation the device must be powered using a power supply unit classified NEC class 2 or SELV with limited energy

ANALOG OUTPUTS

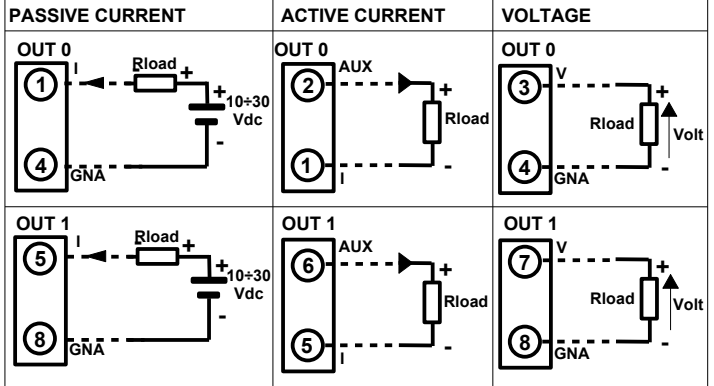

Note: the output channels are not isolated between them.

Terminals AUX of channels connected between them.

Terminals GNA of channels connected between them

RS-485

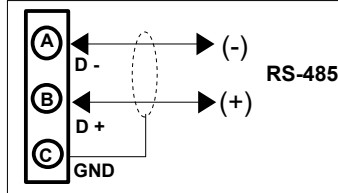

RS-232 (**)

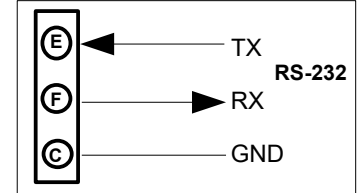

(**) for RS232 version INIT and GND are inverted between them

HOW TO ORDER

In the order, it is necessary to specify the interface type (RS485 or RS232). The device can be supplied with the configuration specified by the customer.

ORDER CODE:

DAT 3022 / 485

Interface type
485 : RS-485
232 : RS-232

■ = Requested
□ = Optional